



A New Frequency Standard and Time Interval Generator

THE problem of measuring frequencies and of standardizing frequency-measuring equipment confronts nearly every present-day electronics and communications laboratory. It is common practice to solve this problem with the use of a frequency standard. In the past primary standards—those checked against time—and secondary standards—those checked against a primary standard—have both been used relatively

widely. However, the reliability and convenience of standardizing with the Bureau of Standards transmissions from Station WWV have resulted in the almost exclusive current use of secondary frequency standards as the principal laboratory source of accurate frequencies. It is desirable that the secondary standard in use be as versatile as possible in addition to being accurate and relatively inexpensive.

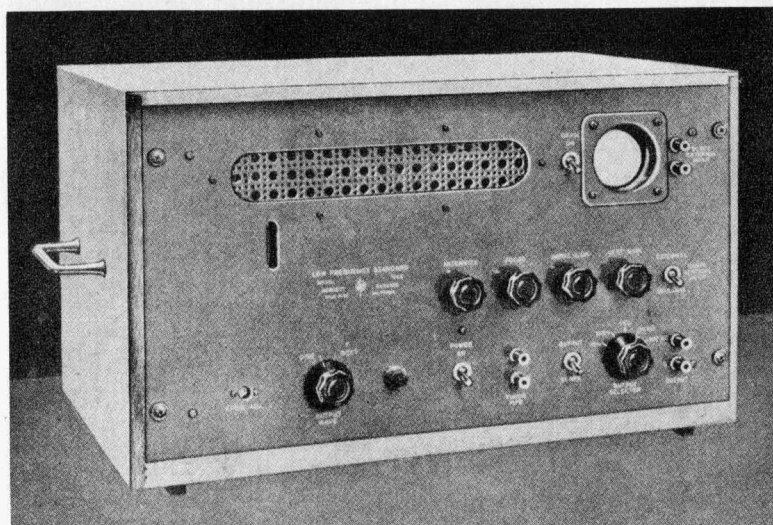

Figure 1. Model 100D Low Frequency Standard.

THE Model 100D Secondary Frequency Standard shown in Figure 1 has been developed with the above general requirements in mind. This standard generates five sinusoidal standard frequencies: 100 kc, 10 kc, 1 kc, 100 cps, and 10 cps. The equipment also generates rectangular waves at all the above repetition rates except 100 kc. Harmonics as high as five megacycles can be obtained from these rectangular waves for measurement purposes. In addition to the sinusoidal and rectangular voltages, the standard generates marker pips at 100-microsecond intervals. A self-contained oscilloscope

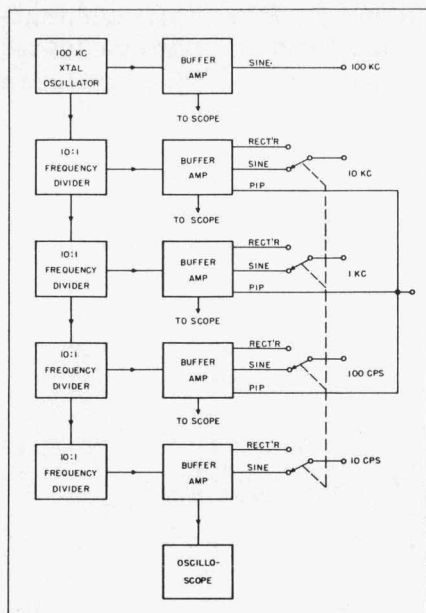

Figure 2. Block Diagram of 100D Circuit.

further contributes to the convenience with which external frequencies can be measured.

CIRCUIT DESCRIPTION

The circuit is shown in block form in Figure 2. A crystal-controlled oscillator operating at 100 kc controls the stability of all frequencies generated by the instrument. The frequencies of 10 kc, 1 kc, 100 cps, and 10 cps are obtained from four 10:1 cascaded frequency dividers which are driven by the 100 kc precision oscillator.

Each divider operates its own isolating amplifier so that all sine waves and rectangular waves generated by the instrument are independently available for external use. The output of the divider circuits and of the precision oscillator are applied to the self-contained oscilloscope to permit the measurement of external frequencies by means of Lissajous figures.

BASIC CIRCUIT

The basic oscillator with a typical divider circuit is shown in Figure 3. The oscillator is a modified Pierce circuit using a very low-temperature-coefficient crystal. The crystal itself is stabilized by an aging period of several months, during which time

the crystal drift and activity are carefully observed and recorded. Housing for the crystal is a double-chamber oven, temperature-controlled by a mercury thermostat having a differential of one-tenth degree Centigrade. Control of the oven and stability of the crystal are such that an overall accuracy within approximately two parts per million is provided over an interval of one week.

Tube V3 in Figure 3 is the actual frequency divider, operating as a controlled one-shot multivibrator. The time constants of the circuit are adjusted so that the circuit is triggered by every tenth cycle of the oscillator.

Assuming for a moment that the oscillator is not operating, the operation of the circuit can be described as follows: In a quiescent state tube V3 operates in such a manner that the plate is at a higher voltage than the screen grid but draws no current. This is explained by the fact that the suppressor grid is sufficiently negative with respect to the cathode to cut off the plate current. Therefore, the screen grid acts as a plate for the space current. The control grid is at cathode potential and is thus drawing heavy current. The cathode of diode V2 is connected to a higher dc voltage than its plate so that V2 is an open circuit to positive voltages and to small negative voltages applied to its cathode.

When the oscillator is operating, the negative portion of the oscillator

output is large enough to activate diode V2 and trigger a multivibrator action in V3: The negative voltage is passed from the plate of V3 to the control grid through C1. The negative control grid reduces the space current, causing the screen voltage to rise and the cathode voltage to fall. This action reduces the suppressor bias with respect to the cathode sufficiently that current passes through the suppressor grid to the plate. The plate voltage therefore drops rapidly, reinforcing the original negative voltage on the control grid. Because the plate voltage on V3 is now low, the plate of V2 is at a lower voltage than its cathode and no negative trigger voltages can pass through diode V2.

The circuit remains in this condition as the negative charge on the control grid leaks off through resistor R2. As the grid voltage slowly rises, the space current in the tube slowly increases, causing the plate voltage to drop somewhat more. At the same time the cathode voltage slowly rises, increasing the bias on the suppressor grid. Finally, a critical point is reached where the screen has more attraction for the space current than the plate.

When this critical point is reached, the second portion of the multivibrator action occurs: the screen voltage falls rapidly and plate current ceases. This action transfers a positive voltage to the control grid, resulting in more space current and reinforcing

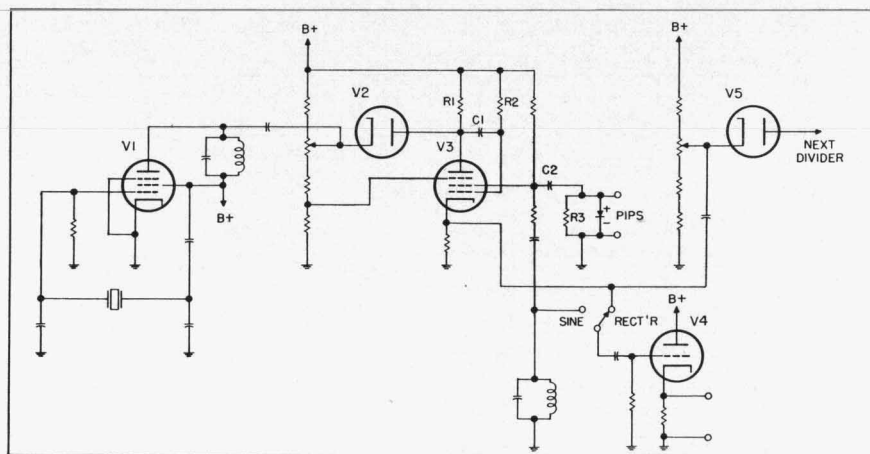

Figure 3A. Basic Circuit of Precision Oscillator and Frequency Divider.

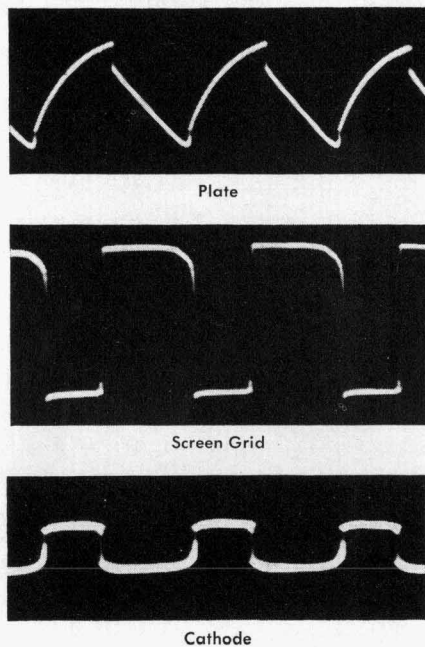

Figure 3B. Waveforms Observed at Tube Electrodes.

the drop in screen voltage. The circuit then becomes quiescent and is prepared for the next negative pulse through diode V2. The time constants in the circuit are adjusted so that the total multivibrator action requires slightly more than nine cycles of the oscillator frequency, the circuit being again ready for triggering on the tenth cycle. Thus, a frequency-dividing action has occurred. Waveshapes at various points in the circuit are shown in Figure 3(B).

This divider circuit is highly stable and will operate for long periods of time without correction. The division is almost entirely dependent upon the values of C1, R1, and R2. The circuit is relatively insensitive to tube replacement or replacement of other components.

The sinusoidal output from the divider is obtained from a tuned circuit that is connected to the screen grid of V3 through a large isolating resistor. This sinusoidal wave is relatively harmonic-free, having less than 4 per cent distortion.

Also obtained from the screen circuit are marker pips. The differentiating circuit C2 and R3 differentiates the rectangular wave, while the crystal diode shorts the negative

portion of the differentiated voltage.

The remaining divider circuits indicated in the block diagram of Figure 2 are connected in cascade and are driven from the rectangular wave at the cathode circuit of V3.

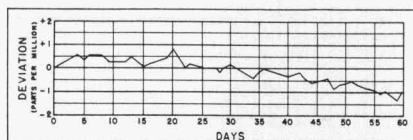

Figure 4. Typical Frequency Stability Curve of 100D Secondary Standard.

STABILITY

A secondary frequency standard by definition is normally dependent upon a primary standard for periodic correction. However, it is desirable that any secondary standard itself have a high order of stability, both on a short-time and a long-time basis. High stability reduces the frequency at which standardization is required and increases the usefulness of the secondary standard. A typical stability curve for this standard is shown in Figure 4.

APPLICATIONS

Low frequencies are most conveniently measured by means of Lissajous figures on an oscilloscope, and the self-contained oscilloscope in the standard is designed to be used for the majority of such measurements. However, for very complex Lissajous figures it is desirable to use a large-screen external oscilloscope.

An external oscillator can be used to advantage to increase the ease of identification of the more complex patterns. For example, when measuring "inconvenient" frequencies such

as 210 cps, the oscillator can be adjusted to 200 cps against the 100 cps output of the standard, resulting in a simple figure-eight pattern on the oscilloscope. By then switching the standard to 10 cps and adjusting the oscillator to the first frequency above 200 cps that results in a sinusoidal pattern, a frequency of 210 cps can be accurately obtained on the oscillator. The oscillator frequency is then compared with the unknown frequency.

High frequency measurements are best made with the aid of a suitable receiver. The transition point between low and high frequency measurements is determined by the characteristics of the equipment at hand, by the stability of the unknown frequency, and by the complexity of the ratio of the unknown frequency to the standard frequency. With modern oscilloscopes and stable frequencies the transition point is above one megacycle.

Using a test set-up like that shown in Figure 5, high-frequency measurements can be made very quickly at frequencies up to approximately six megacycles. At higher frequencies an external harmonic generator is required to increase the harmonic content of the waves generated by the standard. In Figure 5 the unknown frequency and either the 1 kc or 10 kc rectangular-wave output of the standard are connected to the receiver input, resulting in a beat note at the receiver output. Using the 10 kc rectangular-wave output of the standard, this beat will not exceed 5000 cps in the worst case and can be quickly measured with the oscilloscope and oscillator.

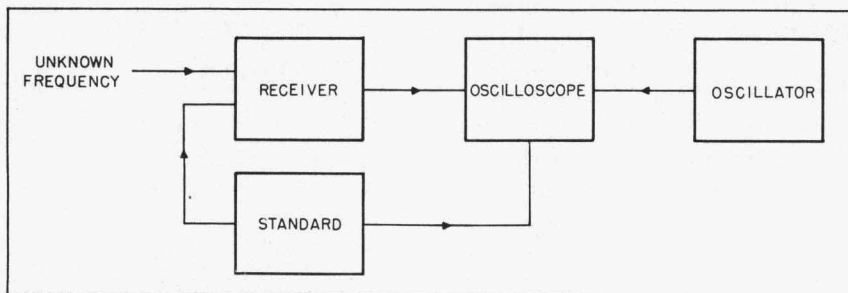

Figure 5. Set-up for Measuring High Frequencies.

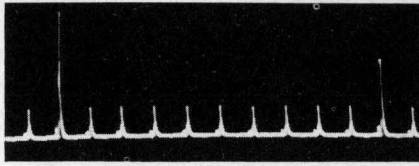
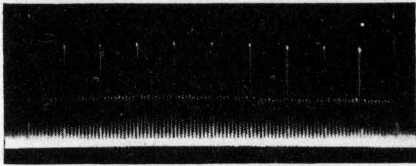

Figure 6A. Compressed and Figure 6B. Expanded Views of Timing Comb.

The above measurement gives the magnitude of the difference frequency between the standard and the unknown but does not indicate whether the standard is above or below the unknown. Therefore, a frequency-shifting circuit has been included in the standard to lower the frequency of the standard by approximately one cycle at 100 kc when a simple panel push-button is depressed. An increase in the beat frequency when the push-button is depressed indicates that the unknown frequency is above the standard frequency by the amount of the original beat, while a decrease in the beat would have the opposite significance.

In some circumstances where the beat note is relatively small, lowering the standard frequency can increase the beat note to indicate that the unknown frequency is higher than the standard, when in fact the unknown is lower than the standard. For example, when measuring a frequency of 4,999,980 cycles per second, a beat note of 20 cycles would be obtained with the five-hundredth harmonic of 10 kc from the standard. Depressing the panel push-button would lower the standard frequency 50 cycles at five megacycles, resulting in a new beat of 30 cycles which is higher than the original beat.

However, had the unknown fre-

quency been 5,000,020 cps, a new beat frequency of 70 cps would have been obtained.

MARKER PIPS

Marker pips are generated every one hundred microseconds by the standard to aid in the measurement of pulse widths and to calibrate synchroscope sweeps. Compressed and expanded views of these pips are shown in Figure 6(A) and 6(B). Every 1000 microseconds a pip of double amplitude is generated, while every 10,000 microseconds a pip of triple amplitude is generated. This arrangement permits quick recognition of the pips when seen on an oscilloscope or synchroscope.

STANDARDIZATION

The rectangular-wave output of the equipment permits very quick standardization with a primary standard such as the Bureau of Standards station WWV. With the aid of a suitable communications-type receiver, harmonics of the 10 kc rectangular wave can be made to beat with the five-megacycle transmission from WWV. This station broadcasts continuously on five megacycles and is receivable at nearly any point in the United States during some portion of the day. A panel trimmer on the equipment is used to adjust the

frequency so that agreement with WWV is obtained.

ALTERNATE MODEL

A modified version of this new standard is also available and is known as the Model 100C. The 100C is basically similar to the 100D but does not include the oscilloscope, rectangular waves, marker pips, frequency-shifting circuit, or 10 cps output. —Brunton Bauer.

SPECIFICATIONS FOR MODEL 100D

ACCURACY: Average stability is within approximately two parts per million per week.

STABILITY: Within one part per million over short-time intervals, such as required to make a measurement.

PANEL CONTROL: Panel trimmer allows oscillator frequency to be varied over range of approximately one-half cycle for correction purposes.

VOLTAGE OUTPUT: Sinusoidal output of at least 5 volts into 5000-ohm or more load.

DISTORTION: Less than 4% distortion in sinusoidal output when operating into 5000-ohm or more load.

RECTANGULAR WAVES: Four different repetition-rate waves are generated corresponding to 10 kc, 1 kc, 100 cps and 10 cps. Harmonics up to 5 megacycles are obtainable from the 10 kc wave; corresponding harmonics obtainable from other rectangular waves.

MARKER PIPS: Generated at intervals of 100 microseconds. A pip of double amplitude is generated every 1000 microseconds while a pip of triple amplitude is generated every 10,000 microseconds.

FREQUENCY-SHIFTING CIRCUIT: Panel push-button lowers precision oscillator frequency by approximately 1 cycle at 100 kc (50 cps at 5 megacycles) to aid in frequency measurements.

SELF-CONTAINED OSCILLOSCOPE: 2" oscilloscope allows any of sinusoidal frequencies to be connected to horizontal-deflecting plates. Input terminals allow external frequencies to be connected to vertical-deflecting plates to allow measurement of frequencies by means of Lissajous figures. Oscilloscope can also be used to prove accuracy of frequency divider circuits.

MOUNTING: Can be supplied either for table or rack mounting. Add letter "R" to model number when rack-mounting desired; i.e., 100DR.

DIMENSIONS: (Rack Type) 19" wide x 10 1/2" high x 13" deep behind panel.
(Table Type) 20" wide x 11 3/4" high x 13 1/4" deep behind panel.

POWER SOURCE: Operates from nominal 115-volt, 50/60 cycle supply. Requires approximately 150 watts. External step-down transformer for operation from 220-volt line can be supplied at slight extra cost.

TUBE COMPLEMENT: Five 6AH6, Two 6AL5, One 2AP1A, Four 6AS6, Two 6L6G, One 5Y3GT, Four 6BH6, One 0A2, One 6AQ6.

SHIPPING WEIGHT: Approximately 90 lbs.

PRICE: Model 100D, \$600.00 f.o.b. Palo Alto, Calif. Model 100C, \$450.00 f.o.b. Palo Alto, Calif. (The Model 100C is similar to Model 100D but does not include oscilloscope, rectangular waves, marker pips, or frequency shifting circuits.)

Data subject to change without notice.

MODELS 100A AND 100B DISCONTINUED

The widely-used Models 100A and 100B Low Frequency Standards have been discontinued and are replaced by the Models 100C and 100D described in the foregoing article. The Model 100C is an improved version of the former 100B and is priced somewhat lower than the 100B, although overall performance has

been increased.

The Model 100D is a new instrument that has been expressly designed to fulfill the growing requirement for a secondary standard with a stability in the order of one part per million and with circuits permitting maximum ease and utility in making measurements.